

Surface Mount Bandpass Filter

CBP-1260C+

50Ω 1200 to 1320 MHz

The Big Deal

- Excellent Rejection
- Low passband Insertion Loss
- Miniature shielded package

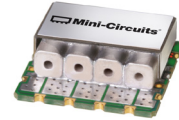

CASE STYLE: MP1766

Product Overview

CBP-1260C+ is a ceramic-coaxial-resonator based bandpass filter in a shielded package fabricated using SMT technology. This filter offers outstanding close in rejection, low insertion loss and high power handling for use in aviation, mobile radio, broadband and fixed wireless.

Key Features

Feature	Advantages
High Selectivity	The CBP-1260C+ filter incorporates High-Q ceramic resonators that enables sharp rejection near passband.
Low Passband VSWR	This filter maintains typical VSWR over passband frequency range making this filter easier to integrate into receiver and transmitter RF chains with less concerns for in band frequency ripple.
Rugged construction	The CBP-1260C+ has been qualified over wide range of thermal, mechanical and environmental conditions including withstanding the stress of extensive solder reflow cycles.

Notes

- A. Performance and quality attributes and conditions not expressly stated in this specification document are intended to be excluded and do not form a part of this specification document.
B. Electrical specifications and performance data contained in this specification document are based on Mini-Circuit's applicable established test performance criteria and measurement instructions.
C. The parts covered by this specification document are subject to Mini-Circuits standard limited warranty and terms and conditions (collectively, "Standard Terms"); Purchasers of this part are entitled to the rights and benefits contained therein. For a full statement of the Standard Terms and the exclusive rights and remedies thereunder, please visit Mini-Circuits' website at www.minicircuits.com/MCLStore/terms.jsp



Surface Mount Bandpass Filter

CBP-1260C+

50Ω 1200 to 1320 MHz

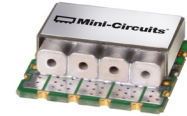

CASE STYLE: MP1766
PRICE: \$26.95 ea. QTY (1-9)

Features

- Low Insertion loss
- High selectivity
- Miniature shielded package

Electrical Specifications at 25°C

Parameter	F#	Frequency (MHz)	Min.	Typ.	Max.	Unit
Pass Band	Center Frequency	—	—	1260	—	MHz
	Insertion Loss	F1-F2	1200-1320	0.7	2	dB
	VSWR	F1-F2	1200-1320	—	1.3	:1
Stop Band, Lower	Insertion Loss	DC-F3	DC-1025	20	30	dB
	VSWR	DC-F3	DC-1025	—	20	:1
Stop Band, Upper	Insertion Loss	F4-F5	1640-2450	20	30	dB
	VSWR	F4-F5	1640-2450	—	20	:1

Applications

- Traffic collision avoidance system (TCAS)
- Aeronautical radio navigation
- Fixed satellite
- Radio astronomy
- Radar and navigation system

Functional Schematic

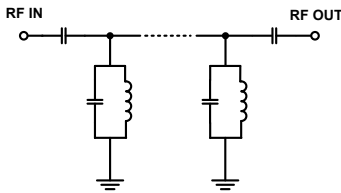

Maximum Ratings	
Operating Temperature	-40°C to 85°C
Storage Temperature	-55°C to 100°C
RF Power Input	5W

Permanent damage may occur if any of these limits are exceeded.

Typical Performance Data at 25°C

Frequency (MHz)	Insertion Loss (dB)	VSWR (:1)	Frequency (MHz)	Group Delay (nsec)
1	103.89	1737.18	1200	4.24
860	64.83	59.91	1204	4.16
1025	30.87	39.49	1208	4.10
1085	15.99	23.18	1214	4.00
1112	8.31	10.31	1218	3.95
1128	4.27	4.66	1220	3.92
1142	2.03	2.32	1236	3.74
1156	1.12	1.41	1230	3.80
1200	0.75	1.08	1234	3.76
1230	0.70	1.04	1238	3.72
1260	0.68	1.08	1244	3.66
1300	0.67	1.09	1250	3.61
1320	0.70	1.13	1260	3.55
1382	1.91	2.61	1264	3.53
1415	4.94	6.66	1276	3.49
1450	9.60	16.56	1284	3.47
1540	20.79	41.37	1296	3.46
1640	30.59	46.96	1300	3.47
2000	57.17	45.72	1310	3.49
2450	58.77	42.38	1320	3.54

Typical Frequency Response

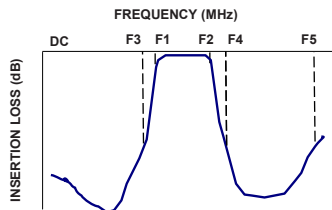

+RoHS Compliant
The +Suffix identifies RoHS Compliance. See our web site for RoHS Compliance methodologies and qualifications

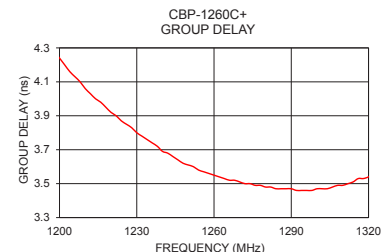
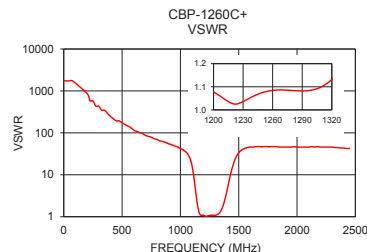
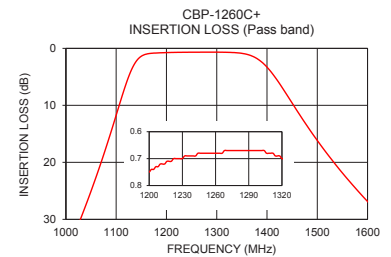
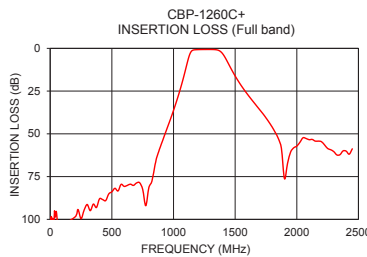

Notes

- Performance and quality attributes and conditions not expressly stated in this specification document are intended to be excluded and do not form a part of this specification document.
- Electrical specifications and performance data contained in this specification document are based on Mini-Circuit's applicable established test performance criteria and measurement instructions.
- The parts covered by this specification document are subject to Mini-Circuits standard limited warranty and terms and conditions (collectively, "Standard Terms"); Purchasers of this part are entitled to the rights and benefits contained therein. For a full statement of the Standard Terms and the exclusive rights and remedies thereunder, please visit Mini-Circuits' website at www.minicircuits.com/MCLStore/terms.jsp



Pad Connections

INPUT	1
OUTPUT	10
GROUND	2,3,4,5,6,7,8,9,11,12,13

Demo Board MCL P/N: TB-684+
Suggested PCB Layout (PL-373)

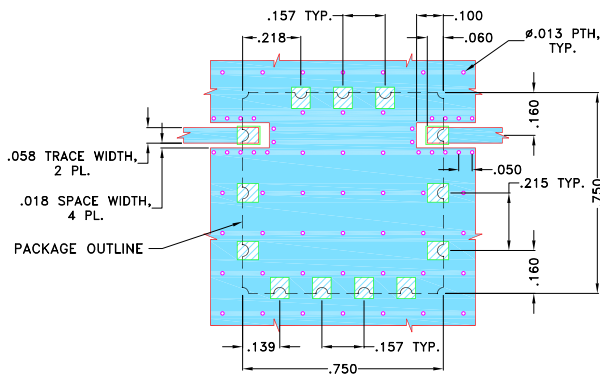

NOTES:

- TRACE WIDTH IS SHOWN FOR OAK (OAK-602) WITH DIELECTRIC THICKNESS .022"±.0015". COPPER: 1/2 OZ. EACH SIDE. FOR OTHER MATERIALS TRACE WIDTH MAY NEED TO BE MODIFIED.
- BOTTOM SIDE OF THE PCB IS CONTINUOUS GROUND PLANE.

- DENOTES PCB COPPER LAYOUT WITH SMOBC (SOLDER MASK OVER BARE COPPER)
- DENOTES COPPER LAND PATTERN FREE OF SOLDERMASK

Outline Drawing

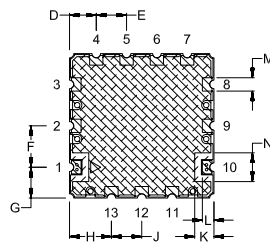
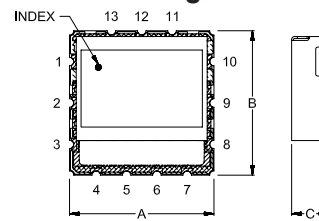

PCB Land Pattern

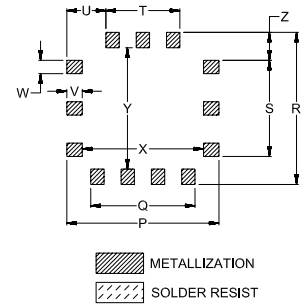

Outline Dimensions (inch)

A	B	C	D	E	F	G	H	J	K	L	M	N
.750	.750	.210	.139	.157	.215	.160	.218	.157	.100	.060	.069	.149
19.05	19.05	5.33	3.53	3.99	5.46	4.06	5.54	3.99	2.54	1.52	1.75	3.78
P	Q	R	S	T	U	V	W	X	Y	Z	wt.	
.790	.541	.790	.499	.384	.203	.080	.069	.630	.630	.145	grams	
20.07	13.74	20.07	12.67	9.75	5.16	2.03	1.75	16.00	16.00	3.68	4.6	

Notes

- A. Performance and quality attributes and conditions not expressly stated in this specification document are intended to be excluded and do not form a part of this specification document.
 B. Electrical specifications and performance data contained in this specification document are based on Mini-Circuit's applicable established test performance criteria and measurement instructions.
 C. The parts covered by this specification document are subject to Mini-Circuits standard limited warranty and terms and conditions (collectively, "Standard Terms"); Purchasers of this part are entitled to the rights and benefits contained therein. For a full statement of the Standard Terms and the exclusive rights and remedies thereunder, please visit Mini-Circuits' website at www.minicircuits.com/MCLStore/terms.jsp

