

NEW!

MMIC

REFLECTIONLESS FILTERS

50Ω DC to 21 GHz

The Big Deal

- Patented design eliminates in band spurs
- Pass band cut-off up to 21 GHz
- Stop band up to 35 GHz
- Excellent repeatability through IPD* process



X-Series

Available in Low Pass, High Pass and Band Pass designs

Product Overview

Mini-Circuits' **X-Series** reflectionless filters employ a novel filter topology which absorbs and terminates stop band signals internally rather than reflecting them back to the source. This new capability enables unique applications for filter circuits beyond those suited to traditional approaches. Traditional filters are reflective in the stop band, sending signals back to the source at 100% of the power level which interact with neighboring components and often result in intermodulation and other interferences. Reflectionless filters eliminate stop band reflections, allowing them to be paired with sensitive devices and used in applications that otherwise require circuits such as isolation amplifiers or attenuators.

Key Features

Advantages

Easy integration with sensitive reflective components, e.g. mixers, multipliers	Reflectionless filters absorb unwanted signals, preventing reflections back to the source. This reduces generation of additional unwanted signals without the need for extra components like attenuators, improving system dynamic range and saving board space.
Enables stable integration of wideband amplifiers	Because reflectionless filters maintain good impedance in the stop band; they can be integrated with high gain, wideband amplifiers without the risk of creating instabilities in these out of band regions.
Cascadable	Reflectionless filters can be cascaded in multiple sections to provide sharper and higher attenuation, while also preventing any standing waves that could affect pass band signals.
Excellent power handling in a tiny surface mount device	High power handling extends the usability of these filters to the transmit path for inter-stage filtering.
Small size, 3x3mm QFN	Allows replacement of filter/attenuator pairs with a single reflectionless filter, saving board space.
Excellent repeatability of RF performance	Through semiconductor IPD process, X-series filters are inherently repeatable for large volume production.
Excellent stability over temperature	With ± 0.3 dB variation over temperature ideal for use in wide temperature range applications without the need for additional temperature compensation.
Operating temperature up to 105°C	Suitable for operation close to high power components.

*IPD – Integrated Passive Device, is a GaAs semiconductor process



Reflectionless Low Pass Filter

XLF-63+

50Ω DC to 6000 MHz

Features

- Match to 50Ω in the stop band, eliminates undesired reflections
- Cascadable
- Excellent Power handling
- Temperature stable, up to 105°C
- Small size, 3 x 3 mm
- Protected by US Patent No. 8,392,495

Applications

- Harmonics Rejection
- Satellite
- Radar
- Military & Space

General Description

Mini-Circuits' XLF-63+ reflectionless filter employs a novel filter topology which absorbs and terminates stop band signals internally rather than reflecting them back to the source. This new capability enables unique applications for filter circuits beyond those suited to traditional approaches. Traditional filters are reflective in the stop band, sending signals back to the source at 100% of the power level. These reflections interact with neighboring components and often result in inter-modulation and other interferences. Reflectionless filters eliminate stop band reflections, allowing them to be paired with sensitive devices and used in applications that otherwise require circuits such as isolation amplifiers or attenuators.



CASE STYLE: DQ1225

+RoHS Compliant

The +Suffix identifies RoHS Compliance. See our web site for RoHS Compliance methodologies and qualifications



Available Tape and Reel
at no extra cost

Reel Size	Devices/Reel
7"	20, 50, 100, 200, 500, 1000, 2000

simplified schematic and pad description

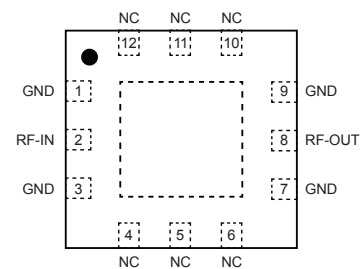
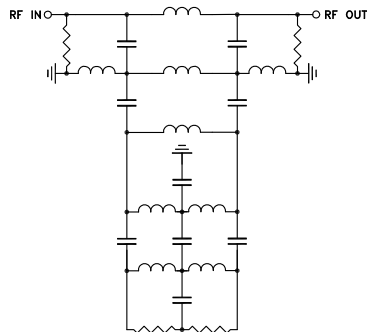

Function	Pad Number	Description
RF-IN	2	RF Input Pad
RF-OUT	8	RF Output Pad
GND	1,3,7,9	Connected to ground
NC (GND Externally)	4,5,6,10,11,12	No internal connection

Electrical Specifications¹ at 25°C

Parameter	F#	Frequency (MHz)	Min.	Typ.	Max.	Unit	
Pass Band	Insertion Loss	DC - F1	DC-6000	—	1.3	1.6	dB
	Frequency Cut-off	F2	8100	—	3.0	—	dB
	VSWR	DC - F1	DC-6000	—	1.3	—	:1
Stop Band	Rejection	F3 - F5	9600 - 17800	12	15	—	dB
	VSWR	F3 - F5	9600 - 17800	—	1.5	—	:1

¹ Measured on Mini-Circuits Characterization Test Board TB-844-63+

Absolute Maximum Ratings⁴

Parameter	Ratings
Operating Temperature	-55°C to +105°C
Storage Temperature	-65°C to +150°C
RF Power Input, Passband (DC-F1) ²	2W at 25°C
RF Power Input, Stopband (F2-F5) ³	150mW at 25°C

² Passband rating derates linearly to 1W at 105°C ambient

³ Stopband rating derates linearly to 75mW at 105°C ambient

⁴ Permanent damage may occur if any of these limits are exceeded.

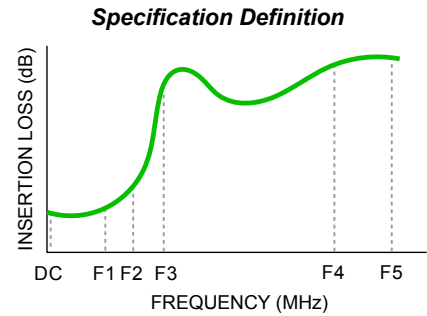

ESD rating

Human body model (HBM): Class 1A (250 to <500V) in accordance with ANSI/ESD 5.1-2001

MSL rating

Moisture Sensitivity: MSL1 in accordance with IPC/JEDEC J-STD-020D

Typical Performance Data at 25°C

Frequency (MHz)	Insertion Loss (dB)	VSWR (:1)
10	0.44	1.03
50	0.41	1.01
100	0.41	1.02
200	0.41	1.04
400	0.43	1.09
600	0.46	1.14
1000	0.52	1.22
1500	0.60	1.29
2000	0.66	1.32
3000	0.76	1.31
4000	0.87	1.32
6000	1.28	1.41
8100	3.06	1.30
9600	16.34	1.07
10500	24.58	1.66
12000	18.46	1.76
14000	19.57	1.32
16000	22.78	1.49
17000	16.37	1.49
17800	14.04	1.81

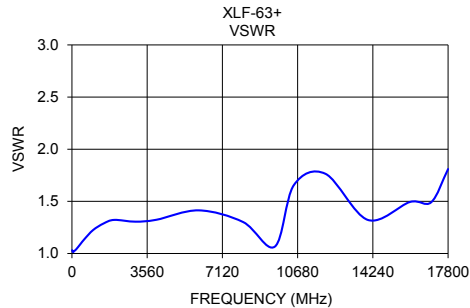
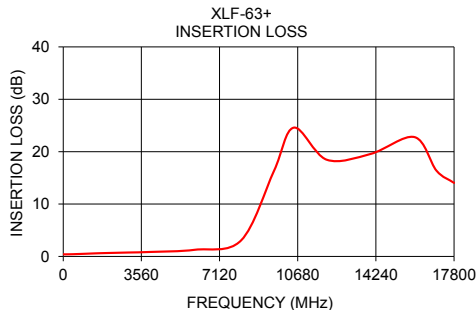

Outline Drawing

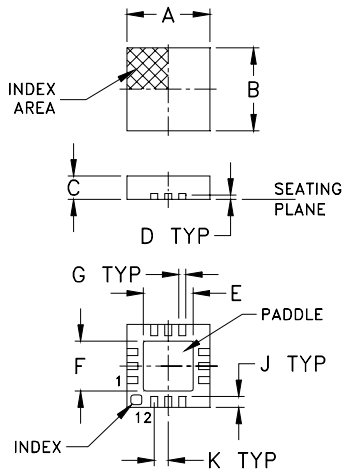



PCB Land Pattern



Demo Board MCL P/N:
TB-844-63+ (without connectors)
TB-844-63C+ (with connectors)
B20-118-F1 Connector sold separately
Suggested PCB Layout: PL-451+



- NOTES:**
 1. TRACE WIDTH PARAMETERS ARE SHOWN FOR ROGERS RO4350B WITH DIELECTRIC THICKNESS .0066"±.0007". COPPER: 1/2 OZ. EACH SIDE. FOR OTHER MATERIALS TRACE WIDTH AND GAP MAY NEED TO BE MODIFIED.
 2. BOTTOM SIDE OF THE PCB IS CONTINUOUS GROUND PLANE.
 DENOTES PCB COPPER LAYOUT WITH SMOBC (SOLDER MASK OVER BARE COPPER).
 DENOTES COPPER LAND PATTERN FREE OF SOLDER MASK.

Outline Dimensions (inch / mm)

A	B	C	D	E	F	G	H	J
.118	.118	.035	.008	.057	.057	.009	---	.016
3.00	3.00	0.89	0.20	1.45	1.45	0.23	---	0.41
K	L	M	N	P	Q	R	wt	
.020	.127	.127	.049	.010	.020	.049	grams	
0.51	3.23	3.23	1.24	0.25	0.51	1.24	0.02	

Tape & Reel Packaging



Product Marking

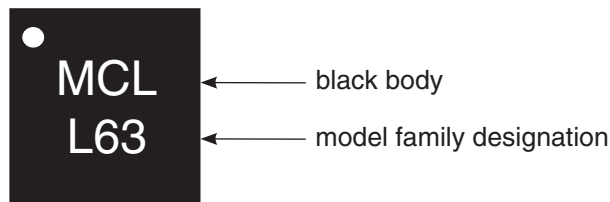

Tape Width, mm	Device Cavity Pitch, mm	Reel Size, inches	Devices per Reel see note	
8	4	7	Small quantity standard	20
				50
		100		
		200		
		500		
		7	Standard	1000, 2000

Application Circuit Example

Pairing mixers with reflectionless filters to improve system dynamic range

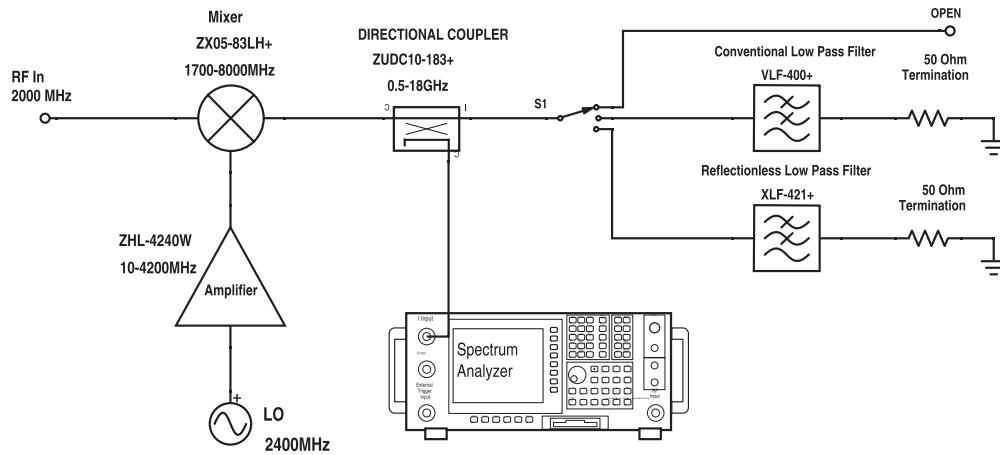

Test block diagram: IF output reflection spectrum with single input frequency

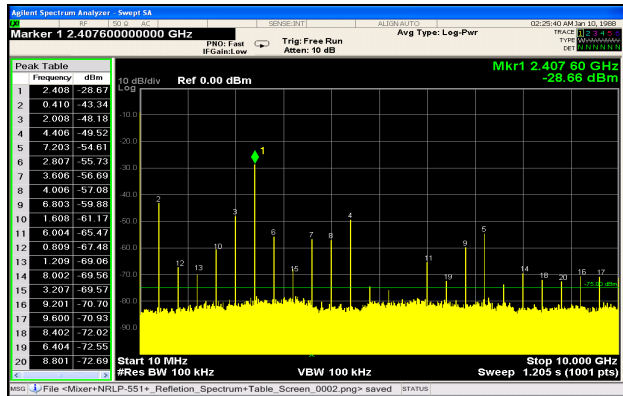

Figure 1. IF output reflection spectrum without filter

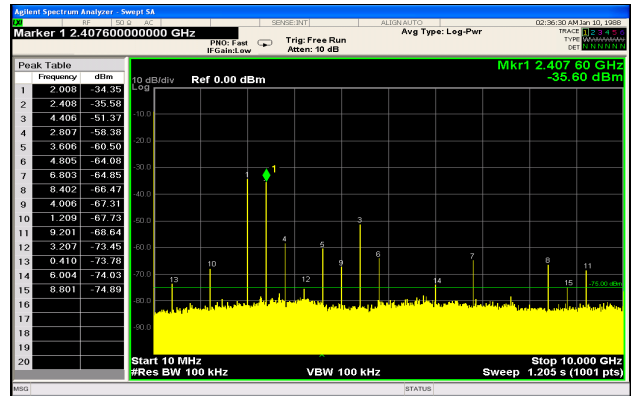

Figure 2. IF output reflection spectrum with conventional filter

An application circuit was assembled to measure the IF reflection spectrum at the output of a mixer when the mixer was paired with a conventional filter versus a reflectionless filter.

While the conventional filter reduces the reflections present when the mixer is used alone (no filter), the reflectionless filter virtually eliminates those reflections altogether.

The reflected signal at marker 1 in the figures above exhibits a reduction of more than 20 dB from -28.7 dBm to -50.3 dBm when the reflectionless filter is used as compared to the conventional filter, thus eliminating unwanted spurious mixing products and improving system dynamic range.

For more information, refer to application note [AN-75-007](#)

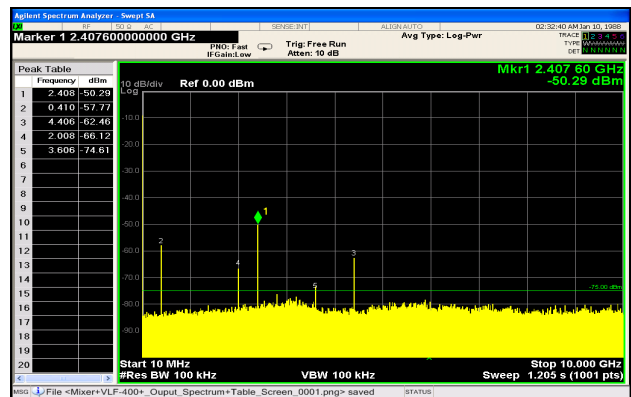

Figure 3. IF output reflection spectrum with reflectionless filter

Additional Notes

- Performance and quality attributes and conditions not expressly stated in this specification document are intended to be excluded and do not form a part of this specification document.
- Electrical specifications and performance data contained in this specification document are based on Mini-Circuits' applicable established test performance criteria and measurement instructions.
- The parts covered by this specification document are subject to Mini-Circuits standard limited warranty and terms and conditions (collectively, "Standard Terms"); Purchasers of this part are entitled to the rights and benefits contained therein. For a full statement of the Standard Terms and the exclusive rights and remedies thereunder, please visit Mini-Circuits' website at www.minicircuits.com/MCLStore/terms.jsp